

NEOCEPTION® eKANBAN LITE Datasheet

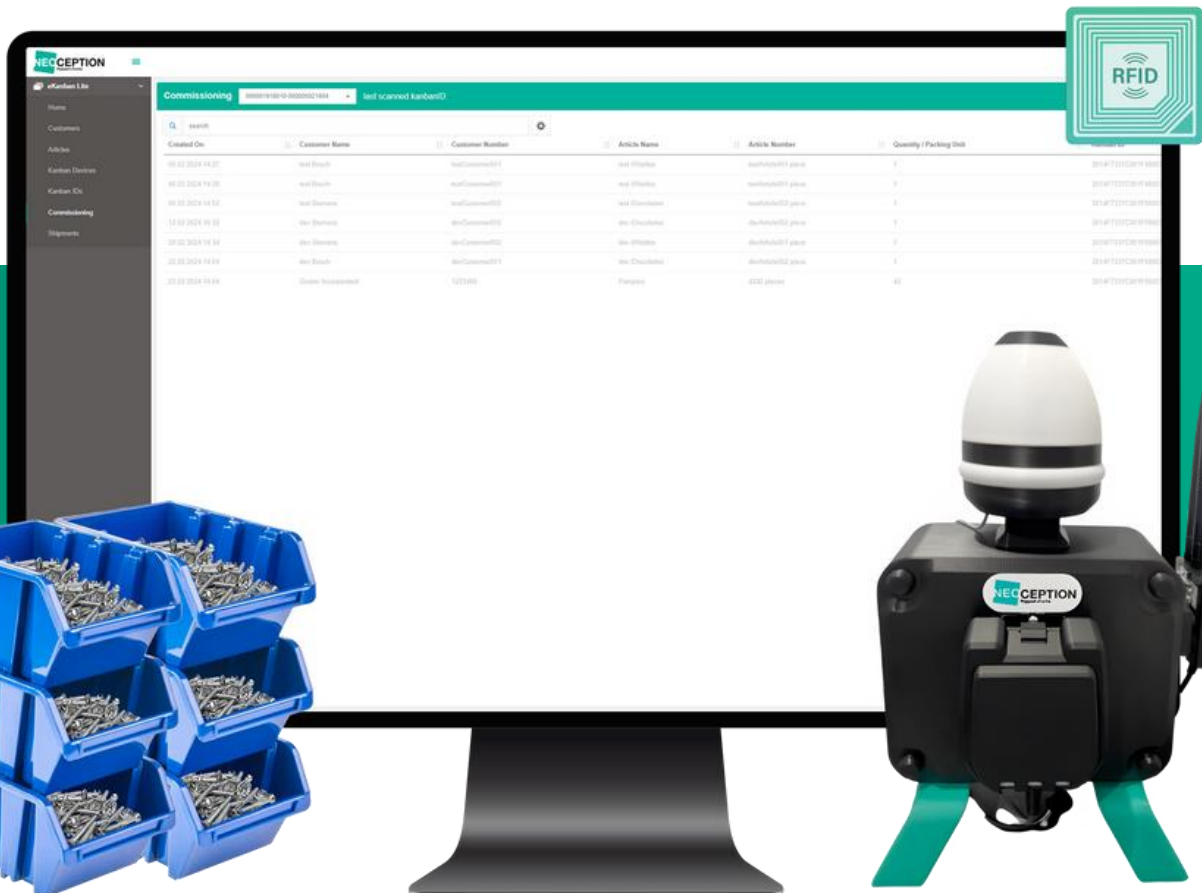



eKanban Lite: RFID scanning station

EKL-RSR-001 | EKL-CSR-001¹

- RFID scanning for accurate tracking
- Automated reordering
- Plug and Play solution
- Connect via LTE, WIFI, or LAN²
- Visual feedback system with Stack Light

FUNCTION

The eKanban Lite solution leverages RFID technology to automate existing and new Kanban systems. RFID eKanban Lite stations are available as commissioning (EKL-CSR-001) or reordering (EKL-RSR-001) stations. The reordering station includes an additional Stack Light that indicates the system's current status and the RFID label processing. Kanban boxes equipped with valid RFID tags can be paired and commissioned at the commissioning station. The reordering station triggers the replenishment of Kanban box materials.

TECHNICAL DATA

General specifications							
Type	EKL-RSR-001 / EKL-CSR-001						
Article number	70185189 / 70185191						
Dimension (W x H x L)	254 x 258 x 210 mm (without Stack Light) 254 x 420 x 210 mm (with Stack Light)						
Weight	<table border="0"> <tr> <td>With package:</td> <td>Without package:</td> </tr> <tr> <td>4582 g (without Stack Light)</td> <td>3345 g (without Stack Light)</td> </tr> <tr> <td>5338 g (with Stack Light)</td> <td>4301 g (with Stack Light)</td> </tr> </table>	With package:	Without package:	4582 g (without Stack Light)	3345 g (without Stack Light)	5338 g (with Stack Light)	4301 g (with Stack Light)
With package:	Without package:						
4582 g (without Stack Light)	3345 g (without Stack Light)						
5338 g (with Stack Light)	4301 g (with Stack Light)						
Networking Interface	10/100/1000 Ethernet Port						
Ambient conditions	5 ... 45 °C						
Storage temperature	5 ... 45 °C						
Protection class	IP 20						
Certification	CE, RoHS, WEEE						

¹ Commissioning station does not include a Stack Light

² An additional LTE router is necessary

RFID specification	
Operating frequency	865 ... 868 MHz: EU, Turkey
RFID transmission power	20 mW
RFID tag detection distance	1-15 cm (varies depending on the working environment)
Electrical specifications	
Power Supply	+24 V DC
Current consumption	≤ 1,5 A
Current consumption with Stack Light	≤ 1 A
Power consumption	max. 36 W



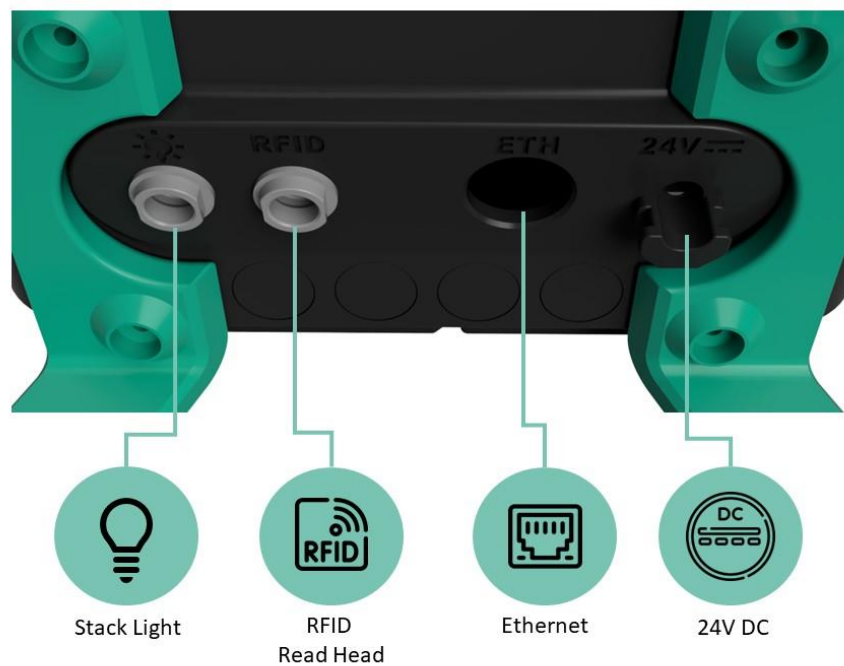

CONNECTIONS

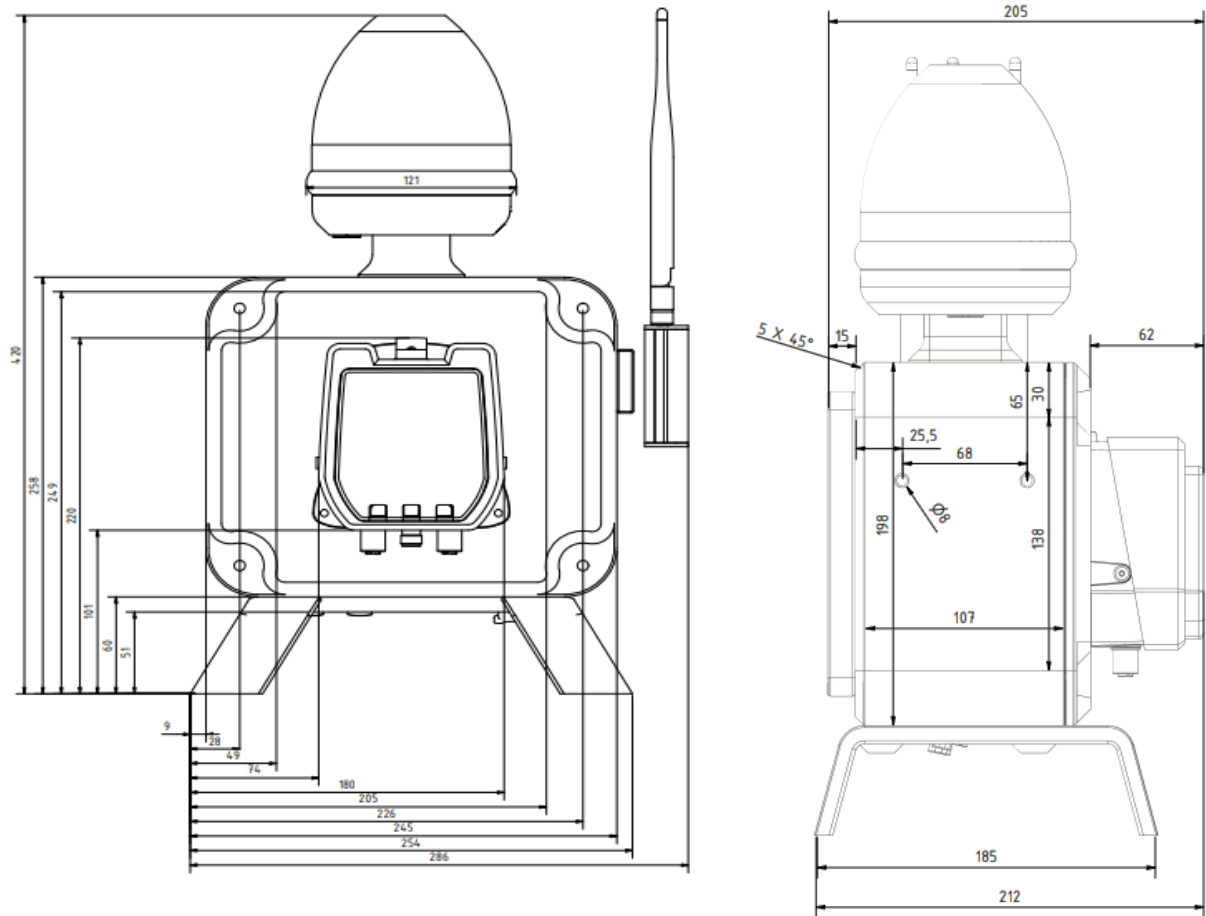

DIMENSIONS



ACCESSORIES

	70185193	LTE/Wifi router hardware package
	70185194	LTE/Wifi router hardware package with SIM card
	70185195	Configurable barcode reader
	256090	UHF RFID label (1000 pcs)
	256089	UHF RFID label laminated (1000 pcs)

WARRANTY

The eKanban Lite is covered by a 12-month limited warranty from the delivery date. This warranty covers any defects in material or workmanship under normal use during the warranty period and covers the repair or replacement of defective parts at no additional cost. Please get in touch with us for technical support or any other issue that could be covered under our warranty.

Exclusions

- Damage resulting from misuse, unauthorized modifications, or external causes such as accidents, improper installation, or power surges.
- Products with serial numbers that have been altered, defaced, or removed.
- Using a different power supply as provided.
- Modification of any provided parts.
- Opening the eKanban Lite box.
- Increasing the cable length over the connected RFID read head or the Stack Light.



CAUTION

Do not attach anything other than the included wires and hardware.

Neglect could result in the device no longer functioning properly.

PRODUCT LIFE AND MAINTENANCE

The eKanban Lite is designed for an operational lifespan of several years under standard usage conditions, given that the following recommended maintenance is provided:

- **Regular Inspection:** Inspect the outside of the device for any signs of wear, damage, or loose connections. Ensure all cables and connectors are securely fastened.
- **Firmware Updates:** Whenever applied, follow our instructions to update the device's software to ensure it operates with the latest features and security enhancements.

End-of-Life Management

This product complies with the WEEE Directive (2012/19/EU). At the end of its lifespan, the eKanban Lite should not be disposed of with regular household waste. Instead, it is your responsibility to dispose of waste equipment by handing it over to a designated collection point for the recycling of waste electrical and electronic equipment. Contact us if you have any questions regarding the proper disposal of the product.

For more information, please visit our homepage or contact our support team.